

Q4X Stainless Steel Laser Sensor with Dual Discrete Outputs and IO-Link



Quick Start Guide

Class 1 laser CMOS sensor with dual outputs and IO-Link. Patent pending.

This guide is designed to help you set up and install the Q4X sensor with dual discrete outputs and IO-Link. For complete information on programming, performance, troubleshooting, dimensions, and accessories, please refer to the Instruction Manual at www.bannerengineering.com. Search for p/n 190074 to view the Instruction Manual. Use of this document assumes familiarity with pertinent industry standards and practices.

For illustration purposes, the threaded barrel model Q4X images are used throughout this document.



WARNING: Not To Be Used for Personnel Protection

Never use this device as a sensing device for personnel protection. Doing so could lead to serious injury or death. This device does not include the self-checking redundant circuitry necessary to allow its use in personnel safety applications. A sensor failure or malfunction can cause either an energized or de-energized sensor output condition.

Features

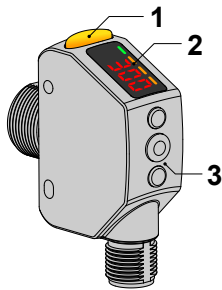

Figure 1. Sensor Features—Threaded Barrel Models

1. Output Indicator (Amber)
2. Display
3. Buttons

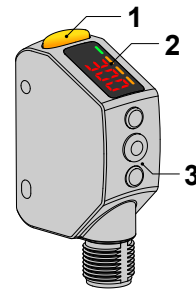

Figure 2. Sensor Features—Flush Mount Models

Display and Indicators

The display is a 4-digit, 7-segment LED. The main screen is the Run mode screen.

For 2-pt, BGS, FGS, and DYN TEACH modes, the display shows the current distance to the target in millimeters. For dual TEACH mode, the display shows the percentage matched to the taught reference surface. A display value of **9999** indicates the sensor has not been taught.

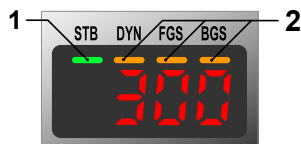

Figure 3. Display in Run Mode

1. Stability Indicator (STB—Green)
2. Active TEACH Indicators
 - DYN—Dynamic (Amber)
 - FGS—Foreground Suppression (Amber)
 - BGS—Background Suppression (Amber)



Note: The indicators represent the currently selected channel. However, if Output 2 is set to something other than LO, DO, or Complementary, then the indicators represent the Channel 1 status.



Output Indicator

- On—Output is on
- Off—Output is off

Active TEACH Indicators (DYN, FGS, and BGS)

- DYN, FGS, and BGS all off—Two-point TEACH mode selected (default)
- DYN on—Dynamic TEACH mode selected
- FGS on—Foreground suppression TEACH mode selected
- BGS on—Background suppression TEACH mode selected
- DYN, FGS, and BGS all on—Dual TEACH mode selected

Stability Indicator (STB)

- On—Stable signal within the specified sensing range
- Flashing—Marginal signal, the target is outside the limits of the specified sensing range, or a multiple peak condition exists
- Off—No target detected within the specified sensing range

Buttons

Use the sensor buttons (SELECT) (TEACH), (+) (CH1/CH2), and (-) (MODE) to program the sensor.

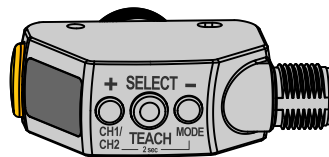

(SELECT) (TEACH)

- Press to select menu items in Setup mode
- Press and hold for longer than 2 seconds to start the currently selected TEACH mode (the default is two-point TEACH)

(+) (CH1/CH2)

- Press to navigate the sensor menu in Setup mode
- Press to change setting values; press and hold to increase numeric values
- Press and hold for longer than 2 seconds to switch between Channel 1 and Channel 2

(-) (MODE)

- Press to navigate the sensor menu in Setup mode
- Press to change setting values; press and hold to decrease numeric values
- Press and hold for longer than 2 seconds to enter Setup mode



Note: When navigating the menu, the menu items loop.

Laser Description and Safety Information



CAUTION: Use of controls or adjustments or performance of procedures other than those specified herein may result in hazardous radiation exposure. Do not attempt to disassemble this sensor for repair. A defective unit must be returned to the manufacturer.

Class 1 Lasers

Class 1 lasers are lasers that are safe under reasonably foreseeable conditions of operation, including the use of optical instruments for intrabeam viewing.

COMPLIES WITH 21 CFR 1040.10 AND 1040.11 EXCEPT FOR DEVIATIONS PURSUANT TO LASER NOTICE No. 50, DATED JUNE 24, 2007. BANNER ENGINEERING CORP. 9714 10TH AVENUE NORTH MINNEAPOLIS, MN 55441	<div style="border: 2px solid black; padding: 5px; display: inline-block;"> CLASS 1 LASER PRODUCT </div>
COMPLIES WITH IEC 60825-1:2007	

Laser wavelength: 655 nm

Output: < 0.20 mW

Pulse Duration: 7 μs to 2 ms

Installation

Install the Safety Label

The safety label must be installed on Q4X sensors that are used in the United States.



Note: Position the label on the cable in a location that has minimal chemical exposure.

1. Remove the protective cover from the adhesive on the label.
2. Wrap the label around the Q4X cable, as shown.
3. Press the two halves of the label together.

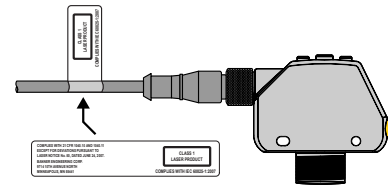

Figure 4. Safety Label Installation

Sensor Orientation

Optimize detection reliability and minimum object separation performance with correct sensor-to-target orientation. To ensure reliable detection, orient the sensor as shown in relation to the target to be detected.

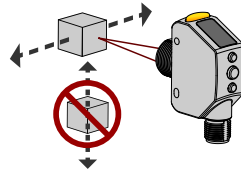

Figure 5. Optimal Orientation of Target to Sensor

See the following figures for examples of correct and incorrect sensor-to-target orientation as certain placements may pose problems for sensing some targets. The Q4X can be used in the less preferred orientation and provide reliable detection performance; refer to the *Performance Curves* for the minimum object separation distance required for each case.

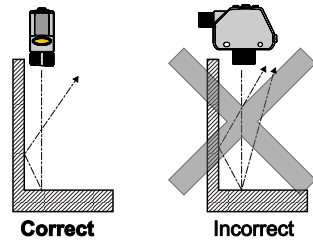

Figure 6. Orientation by a wall

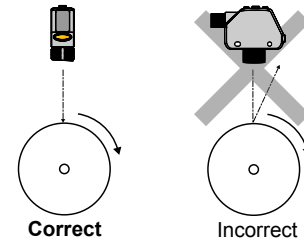

Figure 7. Orientation for a turning object

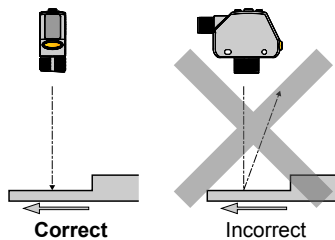

Figure 8. Orientation for a height difference

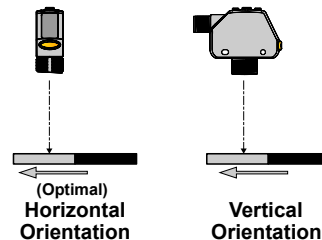

Figure 9. Orientation for a color or luster difference

Mount the Sensor

1. If a bracket is needed, mount the sensor onto the bracket.
2. Mount the sensor (or the sensor and the bracket) to the machine or equipment at the desired location. Do not tighten the mounting screws at this time.
3. Check the sensor alignment.
4. Tighten the mounting screws to secure the sensor (or the sensor and the bracket) in the aligned position.

Wiring Diagram

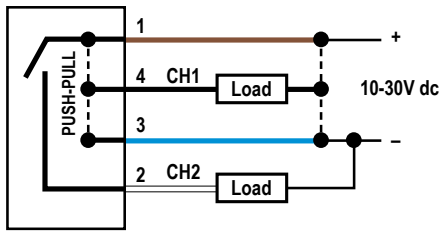

Figure 10. Channel 2 as PNP discrete or PFM output

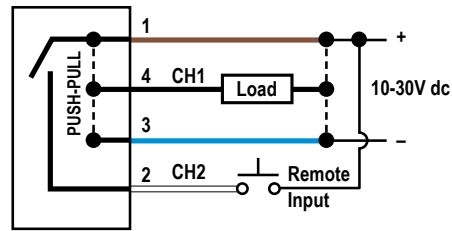
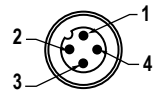

Figure 11. Channel 2 as remote input



- Key
- 1 = Brown
 - 2 = White
 - 3 = Blue
 - 4 = Black



Note: Open lead wires must be connected to a terminal block.



Note: The Channel 2 wire function is user-selectable. The default for the wire is PNP output. See the Instruction Manual for details regarding use as remote input or PFM output.

Cleaning and Maintenance

Handle the sensor with care during installation and operation. Sensor windows soiled by fingerprints, dust, water, oil, etc. may create stray light that may degrade the peak performance of the sensor. Blow the window clear using filtered, compressed air, then clean as necessary using water and a lint-free cloth.

Sensor Programming

Program the sensor using the buttons on the sensor or the remote input (limited programming options).

In addition to programming the sensor, use the remote input to disable the buttons for security, preventing unauthorized or accidental programming changes. See the Instruction Manual, p/n 190074 for more information.

Setup Mode

Access Setup mode and the sensor menu from Run mode by pressing and holding MODE for longer than 2 seconds. Use **+** and **-** to navigate through the menu. Press SELECT to select a menu option and access the submenus. Use **+** and **-** to navigate through the submenus. Press SELECT to select a submenu option and return to the top menu, or press and hold SELECT for longer than 2 seconds to select a submenu option and return immediately to Run mode.

To exit Setup mode and return to Run mode, navigate to **End** and press SELECT.



Note: The number that follows a menu option, for example **ech1**, indicates the channel that is selected. For menu items without a number (excluding submenu items), these menu options are only available from Channel 1 and the settings apply to both channels.

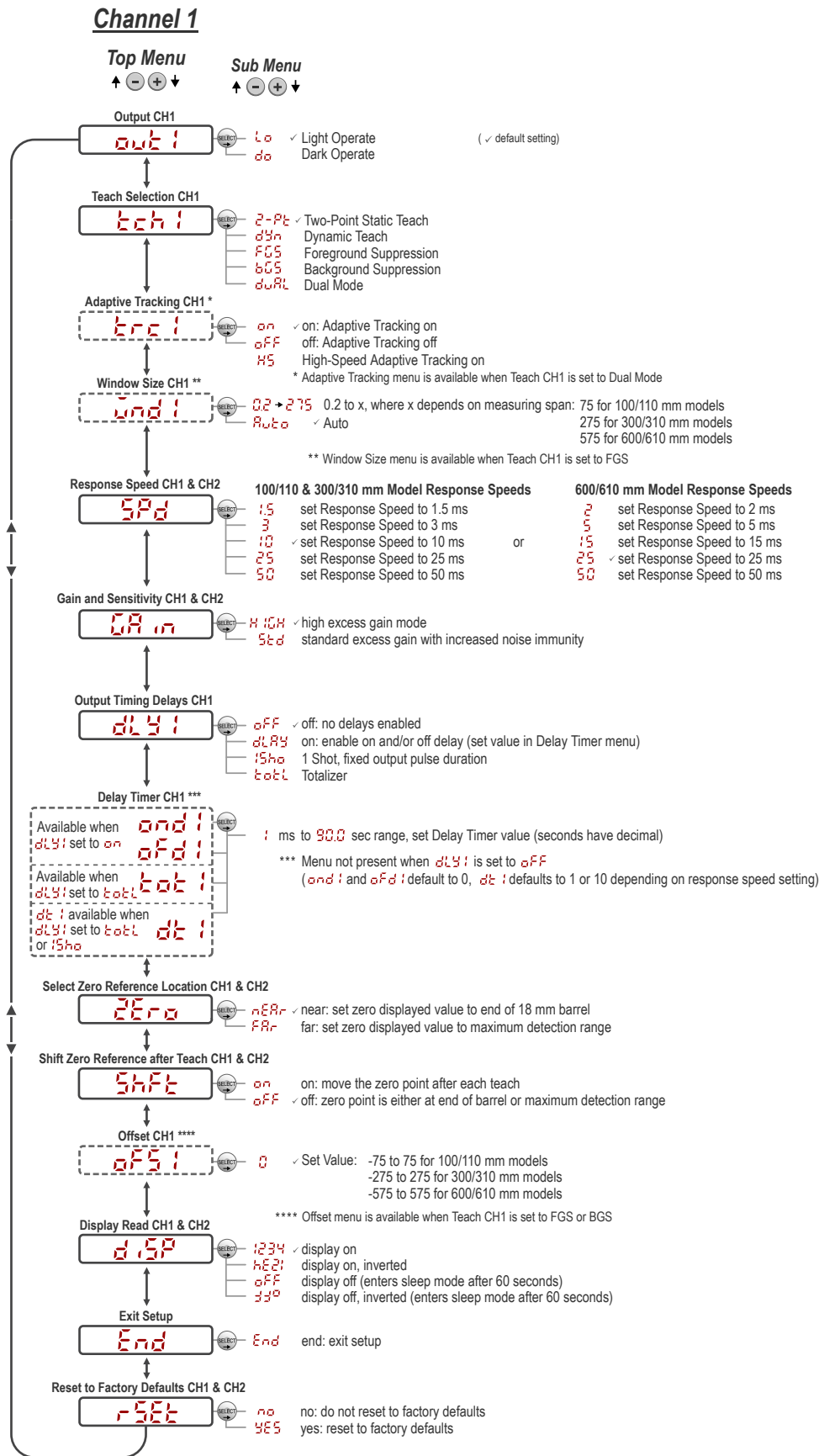

Figure 12. Sensor Menu Map—Channel 1

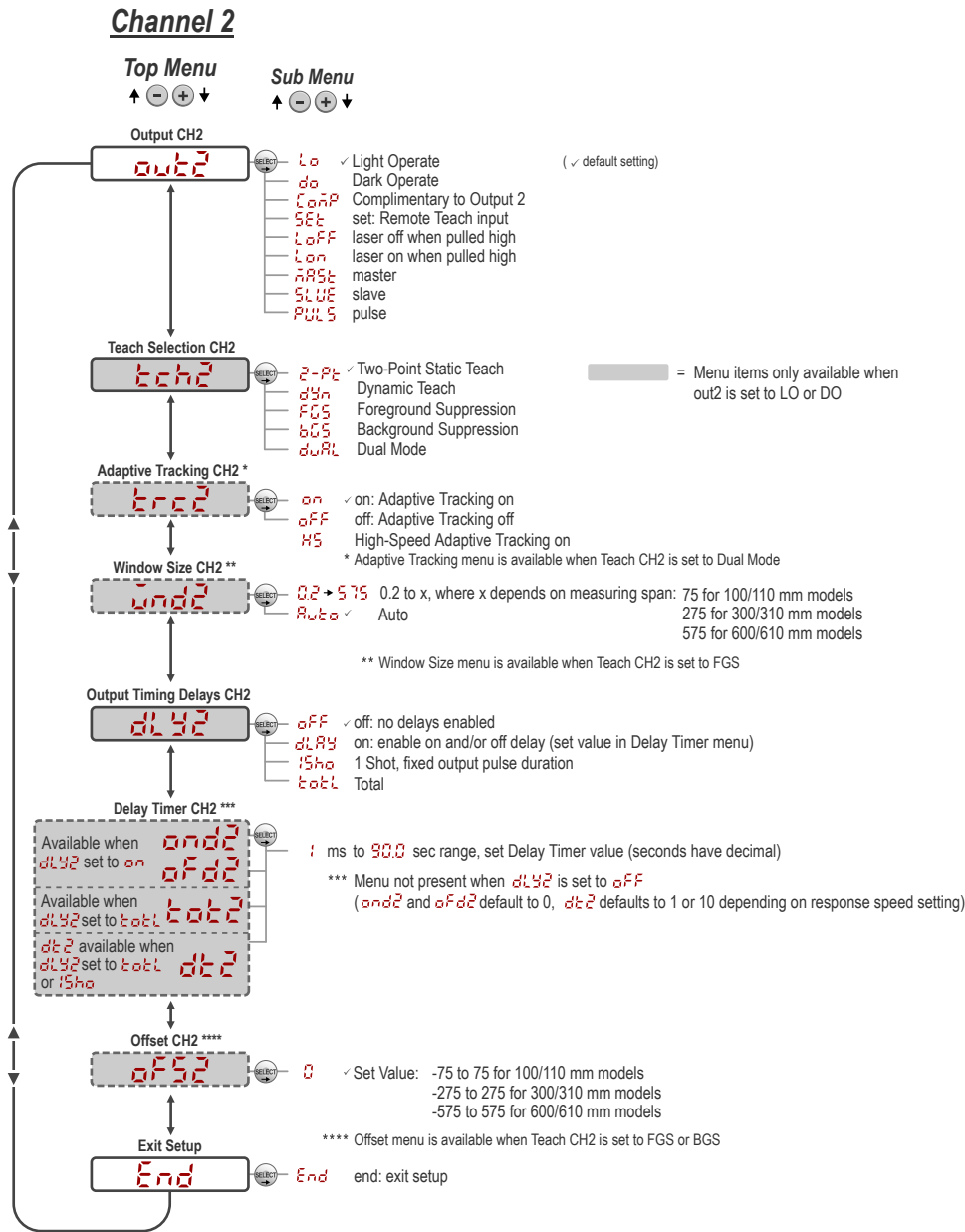

Figure 13. Sensor Menu Map—Channel 2

Basic TEACH Instructions

Use the following instructions to teach the Q4X sensor. The instructions provided on the sensor display vary depending on the type of TEACH mode selected. Two-point TEACH is the default TEACH mode.

1. Press and hold TEACH for longer than 2 seconds to start the selected TEACH mode.
2. Present the target.
3. Press TEACH to teach the target. The target is taught and the sensor waits for the second target, if required by the selected TEACH mode, or returns to Run mode.

Complete steps 4 and 5 only if required for the selected TEACH mode:



4. Present the second target.
5. Press TEACH to teach the target. The target is taught and the sensor returns to Run mode.





See the Instruction Manual for detailed instructions and other available TEACH modes. The TEACH modes include:

- Two-point static background suppression **2-pt** —Two-point TEACH sets a single switch point. The sensor sets the switch point between two taught target distances, relative to the shifted origin location.

- Dynamic background suppression **dyn** —Dynamic TEACH sets a single switch point during machine run conditions. The sensor takes multiple samples and the switch point is set between the minimum and the maximum sampled distances.
- One-point window (foreground suppression) **FGS** —One-point window sets a window (two switch points) centered around the taught target distance.
- One-point background suppression **BGS** —One-point background suppression sets a single switch point in front of the taught target distance. Objects beyond the taught switch point are ignored.
- Dual intensity + distance **dual** —Dual mode records the distance and amount of light received from the reference surface. See [Dual Mode Reference Surface Considerations](#) on page 11 for more information about selecting a reference surface. The output switches when an object passing between the sensor and the reference surface changes the perceived distance or amount of returned light.

Manual Adjustments



Manually adjust the sensor switch point using the  and  buttons.

1. From Run mode, press either  or  one time. The selected channel displays briefly, then the current switch point value flashes slowly.
2. Press  to move the switch point up or  to move the switch point down. After 1 second of inactivity, the new switch point value flashes rapidly, the new setting is accepted, and the sensor returns to Run mode.



Note: When FGS mode is selected (FGS indicator is on), manual adjustment moves both sides of the symmetrical threshold window simultaneously, expanding and collapsing the window size. Manual adjustment does not move the center point of the window.



Note: When dual mode is selected (DYN, FGS, and BGS indicators are on), after the TEACH process is completed, use the manual adjustment to adjust the sensitivity of the thresholds around the taught reference point. The taught reference point is a combination of the measured distance and returned signal intensity from the reference target. Manual adjustment does not move the taught reference point, but pressing  increases the sensitivity, and pressing  decreases the sensitivity. When re-positioning the sensor or changing the reference target, re-teach the sensor.

Locking and Unlocking the Sensor Buttons

Use the lock and unlock feature to prevent unauthorized or accidental programming changes. Three settings are available:







- **wLoc** —The sensor is unlocked and all settings can be modified (default).
- **Lac** — The sensor is locked and no changes can be made.
- **OLac** —The switch point value can be changed by teaching or manual adjustment, but no sensor settings can be changed through the menu.



Note: When the sensor is in either **Lac** or **OLac** mode, the active channel can be changed using (+)(CH1/CH2).

When in **Lac** mode, **Lac** displays when the (SELECT)(TEACH) button is pressed. The switch point displays when (+)(CH1/CH2) or (-)(MODE) are pressed, but **Lac** displays if the buttons are pressed and held.

When in **OLac** mode, **Lac** displays when (-)(MODE) is pressed and held. To access the manual adjust options, briefly press and release (+)(CH1/CH2) or (-)(MODE). To enter TEACH mode, press the (SELECT)(TEACH) button and hold for longer than 2 seconds.

To enter **Lac** mode, hold  and press  four times. To enter **OLac** mode, hold  and press  seven times. Holding  and pressing  four times unlocks the sensor from either lock mode and the sensor displays **wLoc**.

Specifications

Sensing Beam

Visible red Class 1 laser, 655 nm

Supply Voltage (Vcc)

10 to 30 V dc (Class 2 supply) (10% max ripple within limits)

Power and Current Consumption, exclusive of load

< 700 mW

Sensing Range—Threaded Barrel Models

600 mm models: 25 mm to 600 mm (0.98 in to 23.62 in)

300 mm models: 25 mm to 300 mm (0.98 in to 11.81 in)

100 mm models: 25 mm to 100 mm (0.98 in to 3.94 in)

Sensing Range—Flush Mount Models

610 mm models: 35 mm to 610 mm (1.38 in to 24.02 in)

310 mm models: 35 mm to 310 mm (1.38 in to 12.20 in)

110 mm models: 35 mm to 110 mm (1.38 in to 4.33 in)

Output Configuration

First output = IO-Link, Push/pull

Secondary output = PNP only output or input, or pulse frequency modulated output

Output Rating

100 mA max capability each output

100 mA max total load current for sensor

Saturation: < 2 V

Off-state leakage current: < 50 µA PNP at 30 V (N.A. push/pull)

Discrete Output Distance Repeatability

Table 1: 600/610 mm Models

Distance (mm)		Repeatability
Threaded Barrel Models	Flush Mount Models	
25 to 100 mm	35 to 110 mm	± 0.5 mm
100 to 600 mm	110 to 610 mm	± 0.5%

Table 2: 300/310 mm Models

Distance (mm)		Repeatability
Threaded Barrel Models	Flush Mount Models	
25 to 50 mm	35 to 60 mm	± 0.5 mm
50 to 300 mm	60 to 310 mm	± 1% of range

Table 3: 100/110 mm Models

Distance (mm)		Repeatability
Threaded Barrel Models	Flush Mount Models	
25 to 100 mm	35 to 110 mm	+/-0.2 mm

Remote Input

Allowable Input Voltage Range: 0 to Vcc

Active High (internal weak pulldown): High state > (VCC - 2 V) @ 1.5 mA max.

Supply/Output Protection Circuitry

Protected against reverse polarity and transient overvoltages

Response Speed

User selectable, 100, 110, 300, and 310 mm models:

- 1.5 —1.5 milliseconds
- 3 —3 milliseconds
- 10 —10 milliseconds
- 25 —25 milliseconds
- 50 —50 milliseconds

User selectable, 600 and 610 mm models:

- 2 —2 milliseconds
- 5 —5 milliseconds
- 15 —15 milliseconds
- 25 —25 milliseconds
- 50 —50 milliseconds

Delay at Power Up

100, 110, 300, 310 mm models: < 750 ms

600, 610 mm models: < 1.5 s

Maximum Torque

Side mounting: 1 N·m (9 in·lbs)

Nose mounting: 20 N·m (177 in·lbs)

Ambient Light Immunity

> 5,000 lux at 300 mm

> 2,000 lux at 600 mm

Connector

Integral 4-pin M12/Euro-style male quick disconnect (QD)

Construction

Housing: 316 L stainless steel

Lens cover: PMMA acrylic

Lightpipe and display window: polysulfone

Temperature Effect

0.05 mm/°C at < 125 mm (threaded barrel models)/< 135 mm (flush mount models)

0.35 mm/°C at 300 mm (threaded barrel models)/310 mm (flush mount models)

1.0 mm/°C at 600 mm (threaded barrel models)/ 610 mm (flush mount models)

Chemical Compatibility

Compatible with commonly used acidic or caustic cleaning and disinfecting chemicals used in equipment cleaning and sanitation. ECOLAB® certified.

Compatible with typical cutting fluids and lubricating fluids used in machining centers

IO-Link Interface

Supports Smart Sensor Profile: Yes

Baud Rate: 38400 bps

Process Data Widths: 16 bits

I ODD files: Provides all programming options of the display, plus additional functionality.

Application Note

For optimum performance, allow 10 minutes for the sensor to warm up

Beam Spot Size—100/110 mm Models

Table 4: Beam Spot Size—100/110 mm Models

Distance (mm)		Size (Horizontal x Vertical)
Threaded Barrel Models	Flush Mount Models	
25	35	2.4 mm x 1.0 mm
50	60	2.2 mm x 0.9 mm
100	110	1.8 mm x 0.7 mm

Beam Spot Size—300/310 mm and 600/610 mm Models

Table 5: Beam Spot Size—300/310 mm and 600/610 mm Models

Distance (mm)		Size (Horizontal x Vertical)
Threaded Barrel Models	Flush Mount Models	
25	35	2.6 mm x 1.0 mm
150	160	2.3 mm x 0.9 mm
300	310	2.0 mm x 0.8 mm
600	610	1.9 mm x 1.0 mm

Excess Gain using a 90% White Card—100/110/300/310 mm Models

Table 6: **HIGH** Excess Gain (**Std** Excess Gain¹)

Response Speed (ms)	· at 25 mm (100/300 mm models) · at 35 mm (110/310 mm models)	· at 100 mm (100/300 mm models) · at 110 mm (110/310 mm models)	· at 300 mm (100/300 mm models) · at 310 mm (110/310 mm models)
1.5	200	100	20
3	200	100	20
10	1000 (500)	500 (250)	100 (50)
25	2500 (1000)	1250 (500)	250 (100)
50	5000 (2500)	2500 (1250)	500 (250)

Excess Gain using a 90% White Card—600/610 mm Models

Table 7: **HIGH** Excess Gain (**Std** Excess Gain²)

Response Speed (ms)	· at 25 mm (600 mm models) · at 35 mm (610 mm models)	· at 100 mm (600 mm models) · at 110 mm (610 mm models)	· at 300 mm (600 mm models) · at 310 mm (610 mm models)	· at 600 mm (600 mm models) · at 610 mm (610 mm models)
2	280	110	25	6
5	280	110	25	6
15	1000 (360)	400 (150)	80 (30)	20 (7)
25	2000 (1000)	800 (400)	160 (80)	40 (20)
50	4000 (2000)	1600 (800)	320 (160)	80 (40)

Environmental Rating

IEC IP67 per IEC60529
IEC IP68 per IEC60529
IEC IP69K per DIN40050-9

Vibration

MIL-STD-202G, Method 201A (10 Hz to 60 Hz, 0.06 inch (1.52 mm) double amplitude, 2 hours each along X, Y and Z axes), with sensor operating

Shock

MIL-STD-202G, Method 213B, Condition I (100G 6x along X, Y and Z axes, 18 total shocks), with sensor operating

Operating Conditions

-10 °C to +50 °C (+14 °F to +122 °F)
35% to 95% relative humidity

Storage Temperature

-25 °C to +75 °C (-13 °F to +167 °F)

Required Overcurrent Protection



WARNING: Electrical connections must be made by qualified personnel in accordance with local and national electrical codes and regulations.

Overcurrent protection is required to be provided by end product application per the supplied table.

Overcurrent protection may be provided with external fusing or via Current Limiting, Class 2 Power Supply.

Supply wiring leads < 24 AWG shall not be spliced.

For additional product support, go to www.bannerengineering.com.

Supply Wiring (AWG)	Required Overcurrent Protection (Amps)
20	5.0
22	3.0
24	2.0
26	1.0
28	0.8
30	0.5

Certifications



Class 2 power

UL Environmental Rating: Type 1



chemical compatibility certified

ECOLAB is a registered trademark of Ecolab USA Inc. All rights reserved.

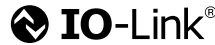

¹ **Std** excess gain available in 10 ms, 25 ms, and 50 ms response speeds only

² **Std** excess gain provides increased noise immunity
Std excess gain available in 15 ms response speed only
Std excess gain provides increased noise immunity

Performance Curves—Threaded Barrel Models

Minimum Separation Distance Between Target and Background for: Uniform and Non-Uniform Targets

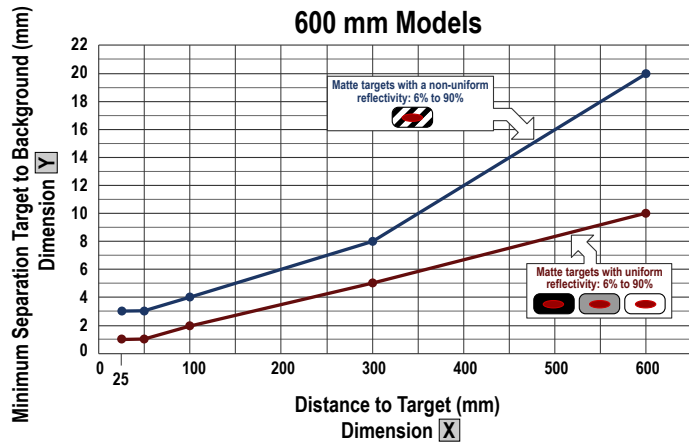
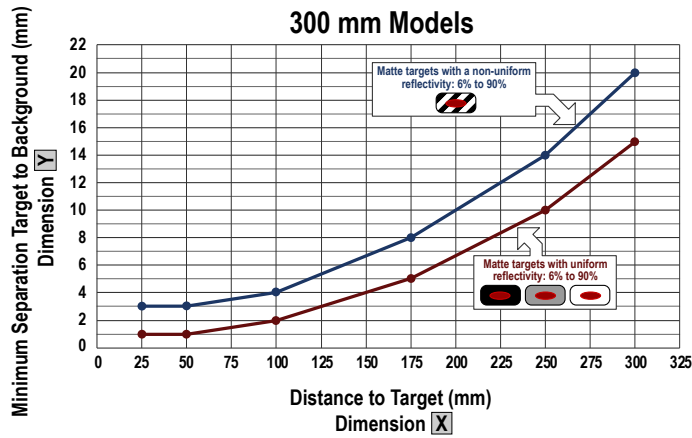
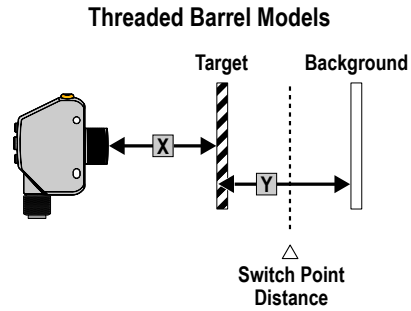
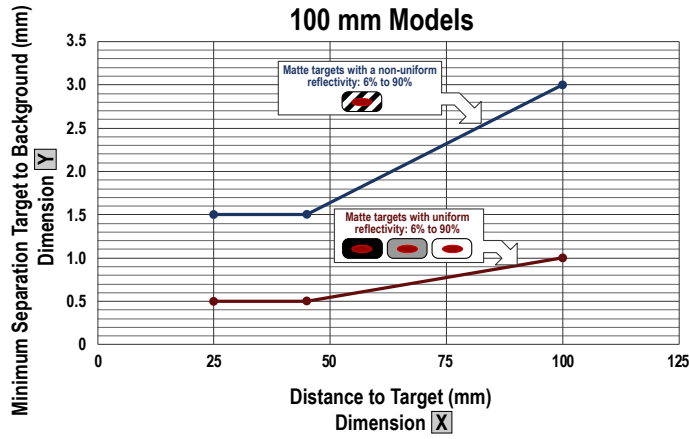

Figure 14. Minimum Object Separation Distance (90% to 6% reflectance)

Performance Curves—Flush Mount Models

Minimum Separation Distance Between Target and Background for: Uniform and Non-Uniform Targets

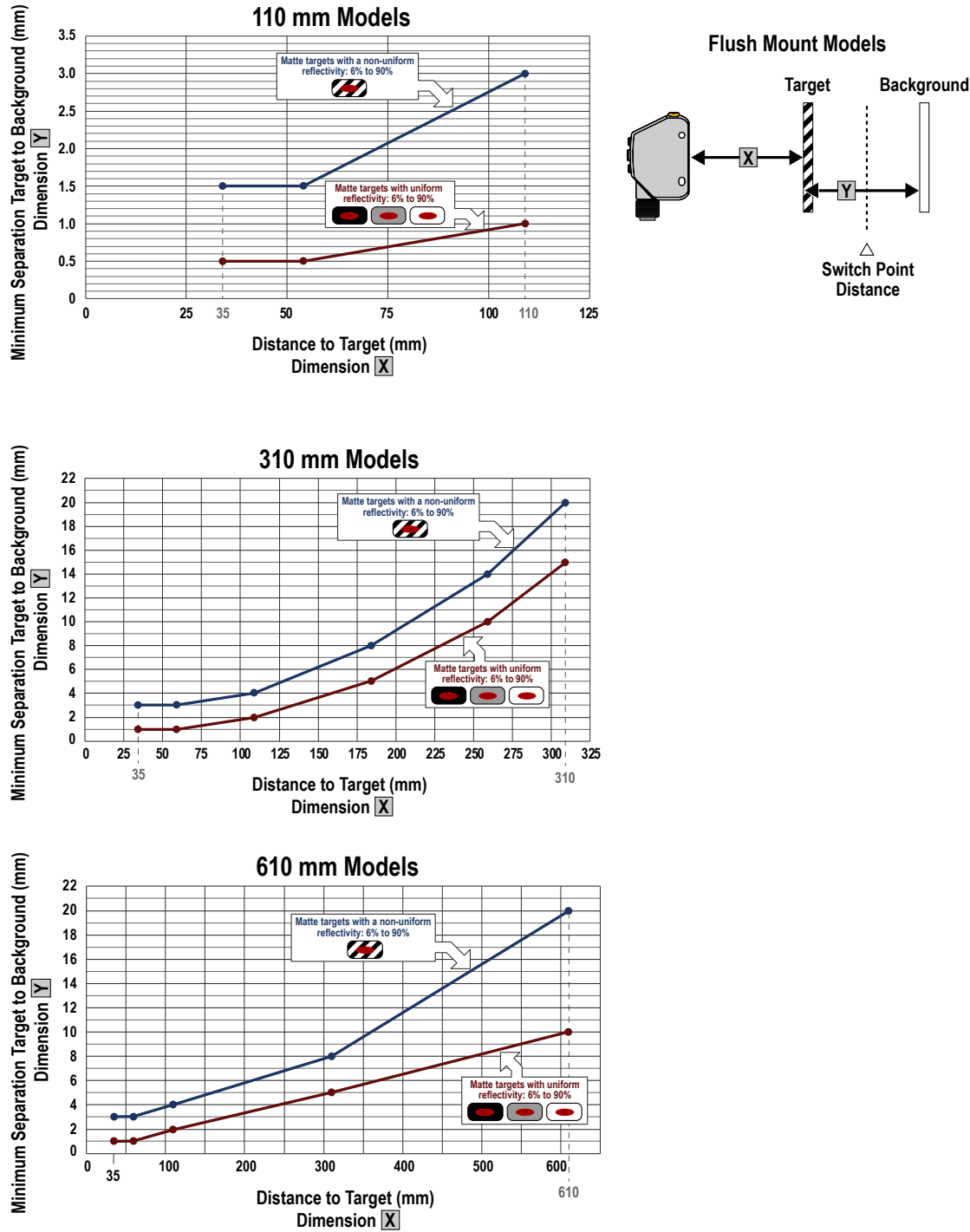

Figure 15. Minimum Object Separation Distance (90% to 6% reflectance)

Dual Mode Reference Surface Considerations

Optimize reliable detection by applying these principals when selecting your reference surface, positioning your sensor relative to the reference surface, and presenting your target. The robust detection capabilities of the Q4X allows successful detection even under non-ideal conditions in many cases. Typical reference surfaces are metal machine frames, conveyor

side rails, or mounted plastic targets. Contact Banner Engineering if you require assistance setting up a stable reference surface in your application. For detailed instructions for detecting clear or transparent objects, refer to the Instruction Manual, p/n 190074.

1. Select a reference surface with these characteristics where possible:
 - Matte or diffuse surface finish
 - Fixed surface with no vibration
 - Dry surface with no build-up of oil, water, or dust
2. Position the reference surface between 50 mm and the maximum sensing range for threaded barrel models or between 60 mm and the maximum sensing range for flush mount models.
3. Position the target to be detected as close to the sensor as possible, and as far away from the reference surface as possible.
4. Angle the sensing beam relative to the target and relative to the reference surface 10 degrees or more.

Banner Engineering Corp. Limited Warranty

Banner Engineering Corp. warrants its products to be free from defects in material and workmanship for one year following the date of shipment. Banner Engineering Corp. will repair or replace, free of charge, any product of its manufacture which, at the time it is returned to the factory, is found to have been defective during the warranty period. This warranty does not cover damage or liability for misuse, abuse, or the improper application or installation of the Banner product.

THIS LIMITED WARRANTY IS EXCLUSIVE AND IN LIEU OF ALL OTHER WARRANTIES WHETHER EXPRESS OR IMPLIED (INCLUDING, WITHOUT LIMITATION, ANY WARRANTY OF MERCHANTABILITY OR FITNESS FOR A PARTICULAR PURPOSE), AND WHETHER ARISING UNDER COURSE OF PERFORMANCE, COURSE OF DEALING OR TRADE USAGE.

This Warranty is exclusive and limited to repair or, at the discretion of Banner Engineering Corp., replacement. IN NO EVENT SHALL BANNER ENGINEERING CORP. BE LIABLE TO BUYER OR ANY OTHER PERSON OR ENTITY FOR ANY EXTRA COSTS, EXPENSES, LOSSES, LOSS OF PROFITS, OR ANY INCIDENTAL, CONSEQUENTIAL OR SPECIAL DAMAGES RESULTING FROM ANY PRODUCT DEFECT OR FROM THE USE OR INABILITY TO USE THE PRODUCT, WHETHER ARISING IN CONTRACT OR WARRANTY, STATUTE, TORT, STRICT LIABILITY, NEGLIGENCE, OR OTHERWISE.

Banner Engineering Corp. reserves the right to change, modify or improve the design of the product without assuming any obligations or liabilities relating to any product previously manufactured by Banner Engineering Corp. Any misuse, abuse, or improper application or installation of this product or use of the product for personal protection applications when the product is identified as not intended for such purposes will void the product warranty. Any modifications to this product without prior express approval by Banner Engineering Corp will void the product warranties. All specifications published in this document are subject to change; Banner reserves the right to modify product specifications or update documentation at any time. Specifications and product information in English supersede that which is provided in any other language. For the most recent version of any documentation, refer to: www.bannerengineering.com.